

LENGTH UP TO 4000 mm.

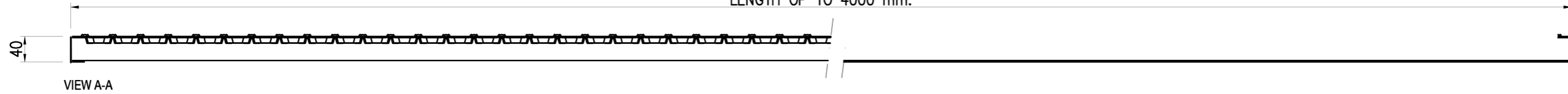

VIEW A-A

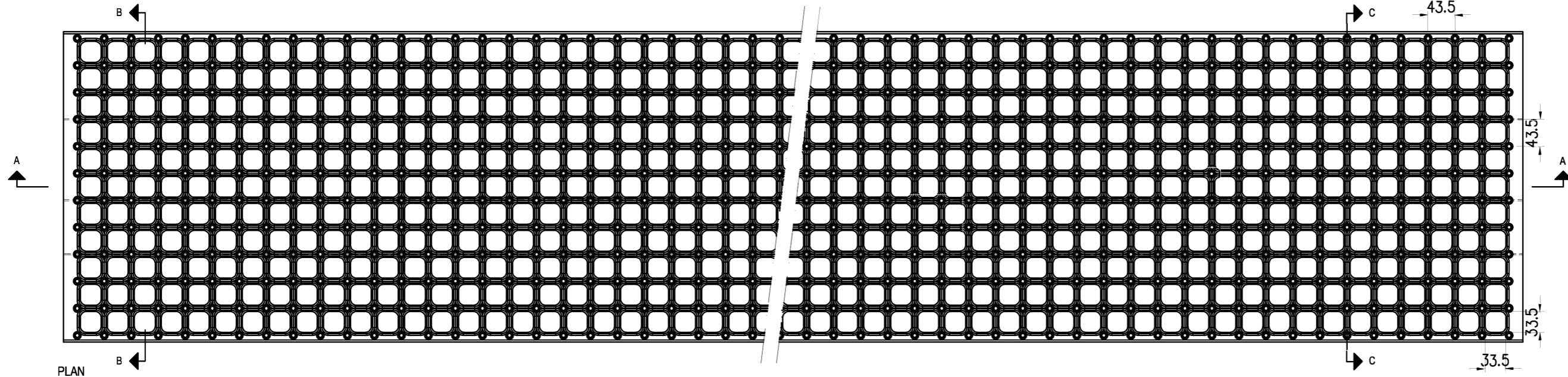

PLAN

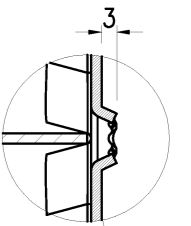

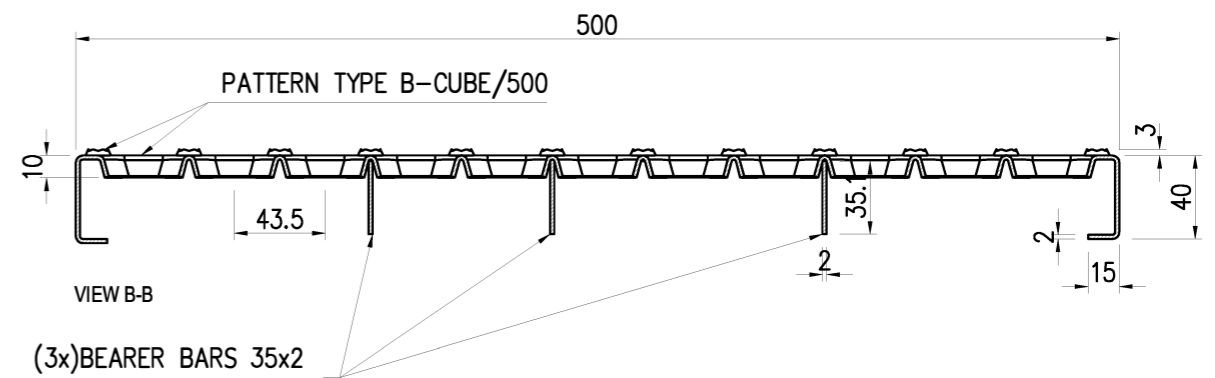
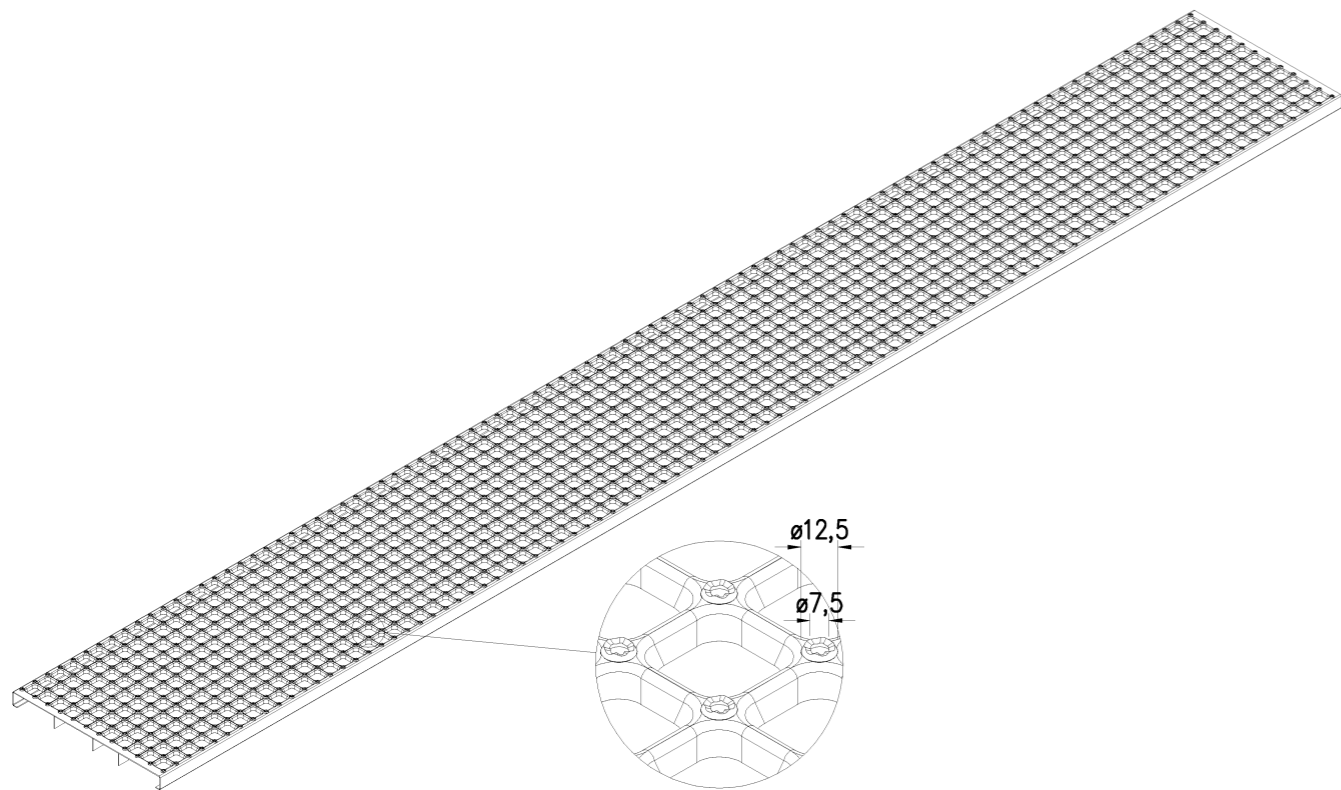

VIEW C-C



VIEW B-B

(3x) BEARER BARS 35x2

28.06.19	Info.	JKJ
Date	Description	Init.
	PcP.A/S Sverigesvej 2-4 T: +45 97 13 12 00 DK-7480 Vildbjerg F: +45 97 13 35 25	member of 
Type:	RIDGEWAY www.ridgeway-online.com	
Panel type B-CUBE		
500x4000x40x15x2 mm.		
Material: 240YP	Surface: Untreated	Scale:
FPC and WPS acc. to EN 1090-1/A1/-2 EXC 2 acc. to DS/EN ISO 3634-3 Welding, tolerances acc. to DS/EN ISO 5817 niveau C Dimensional acc. to DS/EN ISO 1461, if applicable Clearances, surfaces P1 acc. to DS/EN ISO 8501-1 Dimensions without tolerances acc. to DS/ISO 2768 - c All dimensions in mm.		Weight: 8,95 kg/m
PcP Dwg. no.:	SpS-0098-01	Rev. no.:
		01

This drawing is the property of P.P.A/S and is not to be reproduced or used in any manner detrimental to our interests. All rights are reserved.